

# Piiq Roof Top Tent with Internal Racks

## CAPACITY

**Suitable for 2-3 people**

(based on typical rooftop tent dimensions, though not specified)



# Shell Type and Waterproofing

## Hardshell tent

Made from  
**280G**  
polyester-cotton  
canvas

**3000**  
Waterproof  
rating

Tear, snow, and  
heat resistant,  
fully lined with  
an insulator



# Included Items



Extending  
Aluminum  
**Ladder**



Memory  
Cotton  
**Mattress**



Interior  
Ceiling  
**LEDs**

# Storage Solutions



Features  
**Internal Racks**



**3000+** Waterproof Rating

Suitable for up to

 **2-3**  
people



Adventure Series

**Hard-Shell Roof Tent**

# Shell Type and **Waterproofing**

HARDSHELL  
TENT WITH A  
DOUBLE LAYER

**3000+**  
WATERPROOF  
RATING

MADE FROM  
**280GSM**  
FABRIC,  
SUITABLE FOR FOUR-SEASON USE

STURDY ALUMINUM SHELL IN BLACK,  
WITH DARK GREY FABRIC



Hard-Shell Roof Tent

# Capacity

## Storage Solutions

Includes top of roof tent racks for additional storage

## Included Items



Interior dimensions when open:

**82.8" x 58.8" x 46.8"**

Dimensions when closed:

**82.68" x 57.09" x 6.69"**



Ladder

Lamp

Mattress

Installation Kit

Roof tent racks

# White Hardshell Slim Roof Tent

 Suitable for up to **2 people**



**3000+** Waterproof Rating

## Shell Type and **Waterproofing**

**HARDSHELL  
TENT**

**3000+  
WATERPROOF  
RATING**

**MADE FROM  
POLYESTER-COTTON  
CANVAS**

**TEAR, SNOW, AND  
HEAT RESISTANT,  
FULLY LINED FOR  
ALL-SEASON USE**



White Hardshell Slim Roof Tent

# Capacity

↖ ↗  
↘ ↙  
Internal  
dimensions  
**7' x 4'**



# Included Items



Extending  
Aluminum  
**Ladder**



Memory  
Cotton  
**Mattress**



Interior  
Ceiling  
**LEDs**

# Classic Plus Soft Shell Roof Tent

CAPACITY  
**Sleeps 2-3 people**

Interior dimensions:  
**63" x 122" x 50"**



**2-3 Person**

# Shell Type and Waterproofing

## Softshell tent

Made from 420D Polyester Oxford material, **UV and mould-resistant**

Waterproof rating of  
**2500 mm**

Rainfly and tent body crafted from 420D Ripstop Polyester Oxford



# Storage Solutions

Optional annex available separately for additional storage and space

## Included Items

- High-density mattress (63" x 95" x 2.5") with washable cover
- Heavy-duty travel cover (680g/1200D PVC)
- Aluminum anodized sliding ladder



1 tent

1 travel cover

1 aluminum ladder

2 bars

mounting parts



# SkyNomad Pro Roof Tent

 Spacious enough  
for 4-5 persons



# Shell Type and Waterproofing

Aluminum hard shell  
provides superior durability



Hardshell roof tent

Enhanced protection  
against elements

Features WL-Tech  
fabric with  
moisture-wicking  
technology



SkyNomad Pro Roof Tent

# Capacity

Supports an additional **70kg of cargo** on the aluminum hard shell

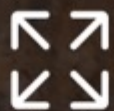

Inner tent size:  
**90.55 x 78.74 x 43.31 inches**

Closed size:  
**84.25 x 49.61 x 10.63 inches**  
excluding ladder



# Included Items



2 inches  
high-density  
mattress  
with soft peach  
skin cover

Sturdy  
telescopic  
ladder  
(supports  
150kg / 331lbs)

Large eave and  
outer fly with  
dull silver  
coating  
(UPF50+)

Two  
large shoe  
pockets  
for convenient  
storage

Family-Sized (4-5 Person)

# Large Rooftop Tent

with Internal Roof Rack System – Black



## Shell Type and Waterproofing



Hardshell  
Tent

3000  
Waterproof  
Rating

Made from  
280G  
polyester-cotton  
canvas

Tear, snow, and heat resistant, fully lined with an insulator

# Storage Solutions

Features an internal roof rack system



# Included Items



Extending  
Aluminum  
**Ladder**



Memory  
Cotton  
**Mattress**



Interior  
Ceiling  
**LEDs**

# Sky Luxe Pro Roof Tent



Suitable for  
2-3 people



# Shell Type and Waterproofing



Made from  
200g/m<sup>2</sup> Oxford fabric  
with PU coating

Waterproof rating:  
5000mm for main tent,  
50000mm for rain cover

Hardshell  
tent

UV protection (UV50+) and fire-resistant, with durable ABS shell material

Sky Luxe Roof Top Tent

# Capacity



Open dimensions:  
**6.9 x 7.2 x 4.2 ft**



Closed dimensions:  
**7.2 x 4.9 x 1.2 ft**

## Storage Solutions

Includes practical storage solutions such as a shoe bag and storage bag

### Optional Accessories:

Attaching awning and annex room for additional space

## Included Items

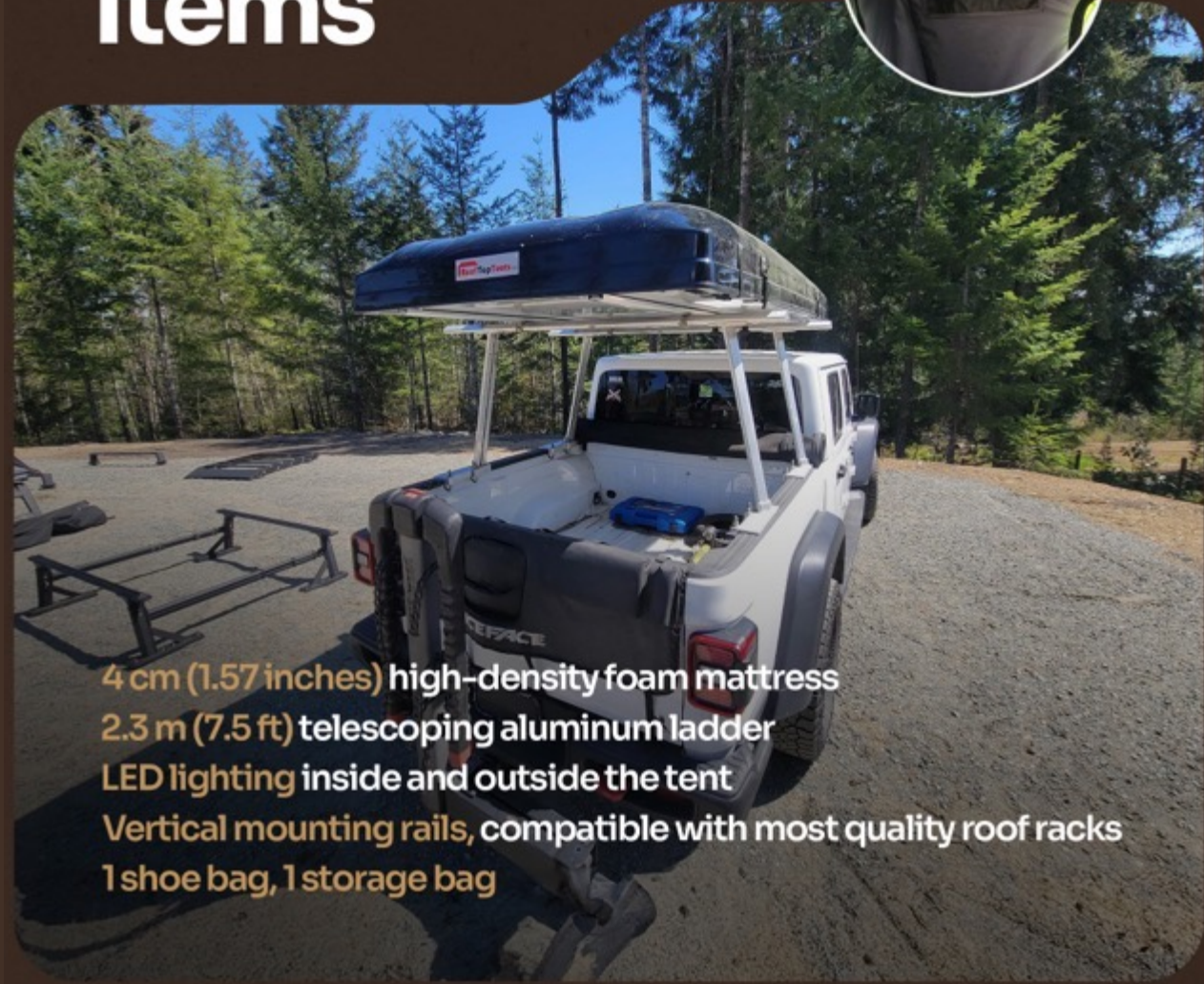

**4 cm (1.57 inches) high-density foam mattress**

**2.3 m (7.5 ft) telescoping aluminum ladder**

**LED lighting inside and outside the tent**

**Vertical mounting rails, compatible with most quality roof racks**

**1 shoe bag, 1 storage bag**

# Skyward Inflatable Roof Top Tent



Suitable for  
2-3 persons

# Shell Type and Waterproofing

Softshell tent with  
an inflatable design



Made from heavy-duty  
600D poly oxford with  
PVC coating, PU5000mm  
waterproof rating

Walls made of 280G  
rip-stop polycotton with  
PU coating, 2000mm  
waterproof rating

Floor made of 210D poly  
oxford with PU coating,  
3000mm waterproof rating



# SkyRover Compact Roof Top Tent



 Suitable for  
**1-2 people**

## Shell Type and **Waterproofing**

UV resistance (UPF50+)  
and weather-resistant



Softshell tent

Made from durable  
600D Rip-Stop  
polyoxford with a  
PU-coated rainfly





Skyward Inflatable Roof Top Tent

# Capacity

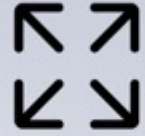

Inner tent size:  
**83" x 53" x 57"**  
Packing size:  
**59" x 43" x 12"**



## Storage Solutions

No specific storage solutions included

# Included Items



## Built-in air pump

powered by vehicle  
cigar lighter or power bank

Dimmable ultra-long

## U-shaped LED

light strip

## Comfortable mattress

with skin-friendly thermal  
cover and 5 cm high-density foam

## Aluminum Telescopic Ladder

(weight excluded from net weight)



SkyRover Compact Roof Top Tent

# Capacity

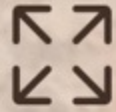

Open dimensions:  
**83 x 47 x 37 in inches**

Closed dimensions:  
**50 x 43 x 13 inches**



# Included Items



High-density  
1.18 inches mattress  
on a 1.57 inches  
EPE foam floor

Telescopic  
aluminum ladder  
(supports up to 150 kg / 330 lbs)

Internal LED  
light strip

Air pillow

# Universal Cross Bar Attach Roof Rails



## Dynamic Load Capacity:

Supports loads  
up to **165 lbs.**

## Universal Compatibility:

- Tailored for vehicles with raised side rails.
- Universally fits most car models, offering versatile daptability.

## Best Use:

- Ideal for outdoor enthusiasts and everyday storage needs.
- Perfect for carrying rooftop accessories and cargo.



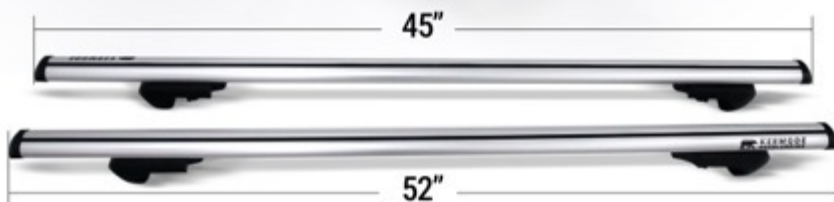

## LENGTHS & WEIGHT

### Available Lengths:

- 1.15 meters (45.28 inches) for smaller vehicles.
- 1.31 meters (51.57 inches) for larger vehicles.

### Weight Details:

- 1.15m bars: Net Weight (N.W): 2.9 kg (6.39 lbs)
- 1.31m bars: Net Weight (N.W): 3 kg (6.61 lbs)

### Quality Material:

- Constructed from Aluminum and Nylon.
- Lightweight yet durable, with a 48mm (1.89 inches) wide aluminum tube.

### Dynamic Load Capacity:

- Supports loads up to 75 kg (165.35 lbs).
- Perfect for a variety of rooftop accessories and cargo needs.

### Quality Material:

- Supports up to 300 kg (661.39 lbs) when stationary.





### **Secure Locking System:**

- Dual-key locking mechanism with two keys.
- Hex key included for secure clamping to side rails.



### **Adjustable Clamps:**

- Clamps extend up to 46 inches (116.84 cm) in usable length.

# BATWING AWNING

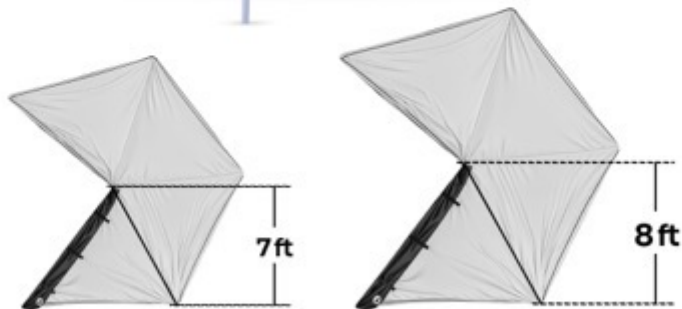

Available in  
**7ft and 8ft**

# Material and Finishing



**Premium Construction Materials**  
- Waterproof Oxford Canvas 420D UV Fabric  
- 600D Poly Cotton Rip-Stop Cove



**Durable Finish**  
- Heavy-duty and water-resistant  
- Mold-resistant properties

**Exceptional Sun Protection**  
- UPF 50+ rating for optimal UV protection



# Dimensions

Available widths:

## 7 feet and 8 Feet



# Weather Resistant?



### Weatherproof Design

Waterproof and  
mold-resistant materials

### All-Season Versatility

Suitable for use in different  
weather conditions

### Reliable Weather Protection

Provides shade and  
shelter from sun and rain



Sunny



Cloudy



Windy



Snowing



Rainy



Storm



# Mega Power 1200W Battery



1008Wh  
Battery



1200W  
Power

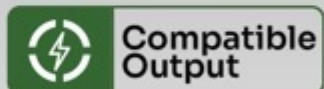

Compatible  
Output



- Temperature Protection
- Overload Protection
- Overcurrent Protection
- Over Discharge Protection
- Short Circuit Protection
- Overvoltage Protection

# Fast Charging

Standard charger,  
about 1.5 hours



Standard charger,  
about 1.5 hours



200W solar  
photovoltaic panel,  
about 5 hours



SCcharger,  
about 5 hours





# Power Everything You Need



# LifeSpan 5 times longer than others



Battery

Lithium iron  
phosphate

# Different Versatile Outlets



# Dual Wireless Charging

Charge compatible devices without cables.





12.01

7.87

12.01

# Compact Design

Easy to carry with dimensions of 12.01 inches x 12.01 inches x 7.87 inches.

# Multiple Ports:

USB and Type-C interfaces for flexible device connectivity.



# Rapid Charging

PD 60W quick charge and AC  
110V output for fast device  
charging



# Versatile Charging Methods

Charge via AC, solar, vehicle, and onboard recharging.



# Outdoor Power Supply

Output Power: 220W Rated Power: 330W

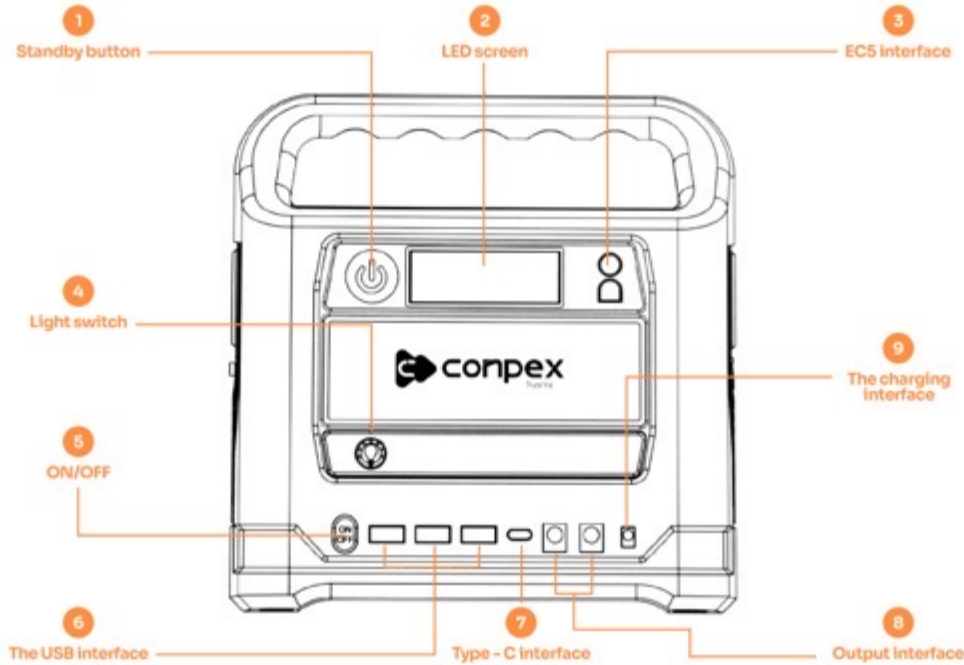

# Multifunctional Use



About 2.6 hours  
Electric rice cooker (300W)



About 140 times  
SLR (1865mAh)



About 12 hours  
Onboard refrigerator (65W)



About 1 hour  
Hot water bottle (800W)

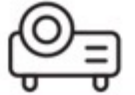

About 8 hours  
Projector (100W)



About 13 times  
UAV (60W)

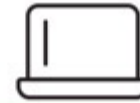

About 9 times  
Notebook (87W)

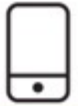

About 99 times  
Phone (2658mAh)



About 12 hours  
Electric drill (75W)



About 13 hours  
Television (60W)



# Wheel Table

## Quick and Easy Setup

Step 1

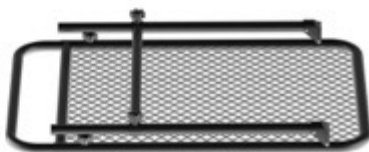

Step 2



Step 4



Step 3



# Lightweight and Portable Design





# Durable Metal Mesh Construction

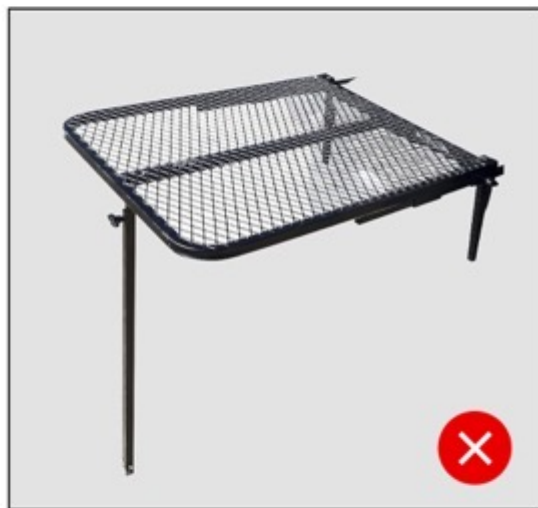

## Why Buying From Us?

Table legs are thicker, more stable & durable than others

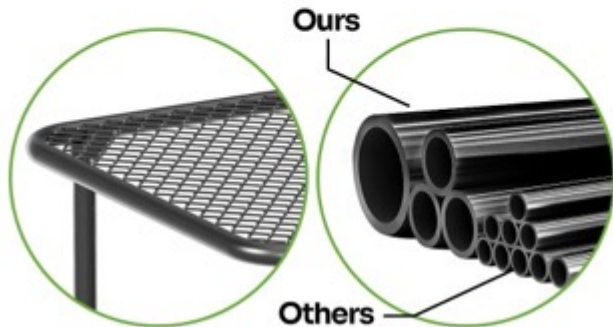

# Versatile Size for All Your Needs

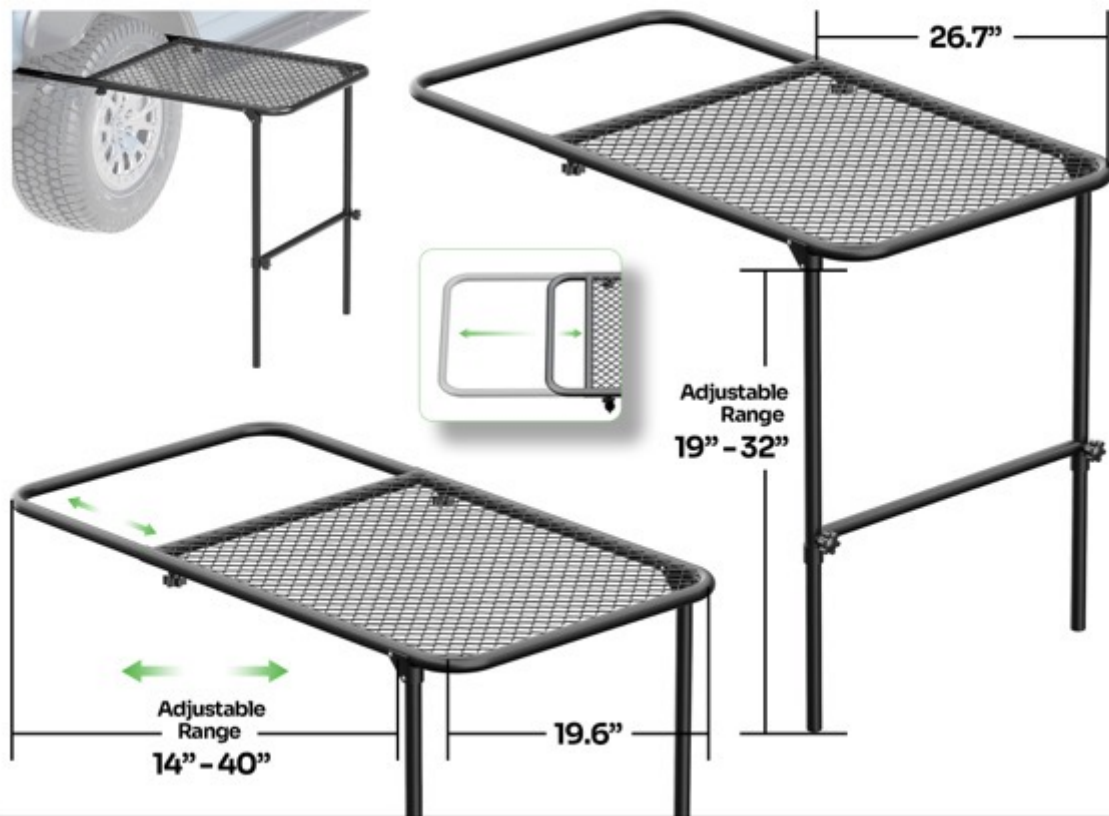

# Camping Grill



# Installation Process

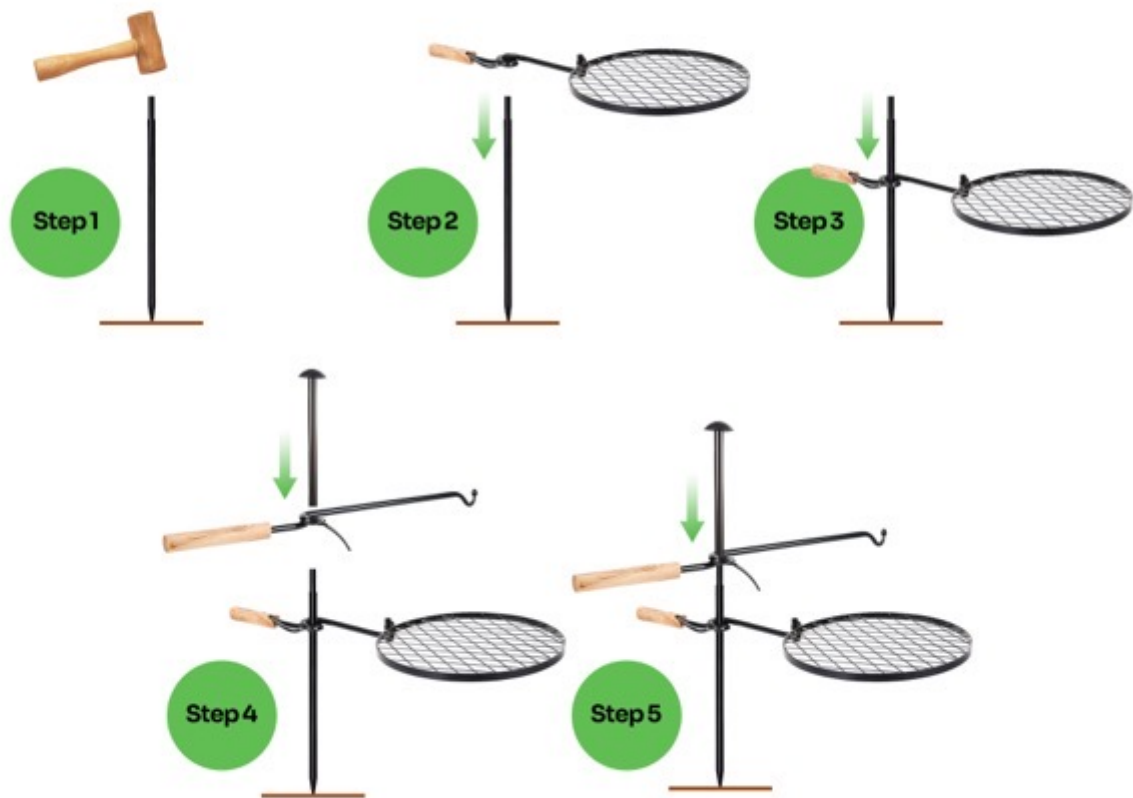

# Durable Construction



Made of heavy-duty steel,  
rust-proof, and can withstand  
temperatures up to  
**572°F (300°C).**



# Adjustable Cooking Height

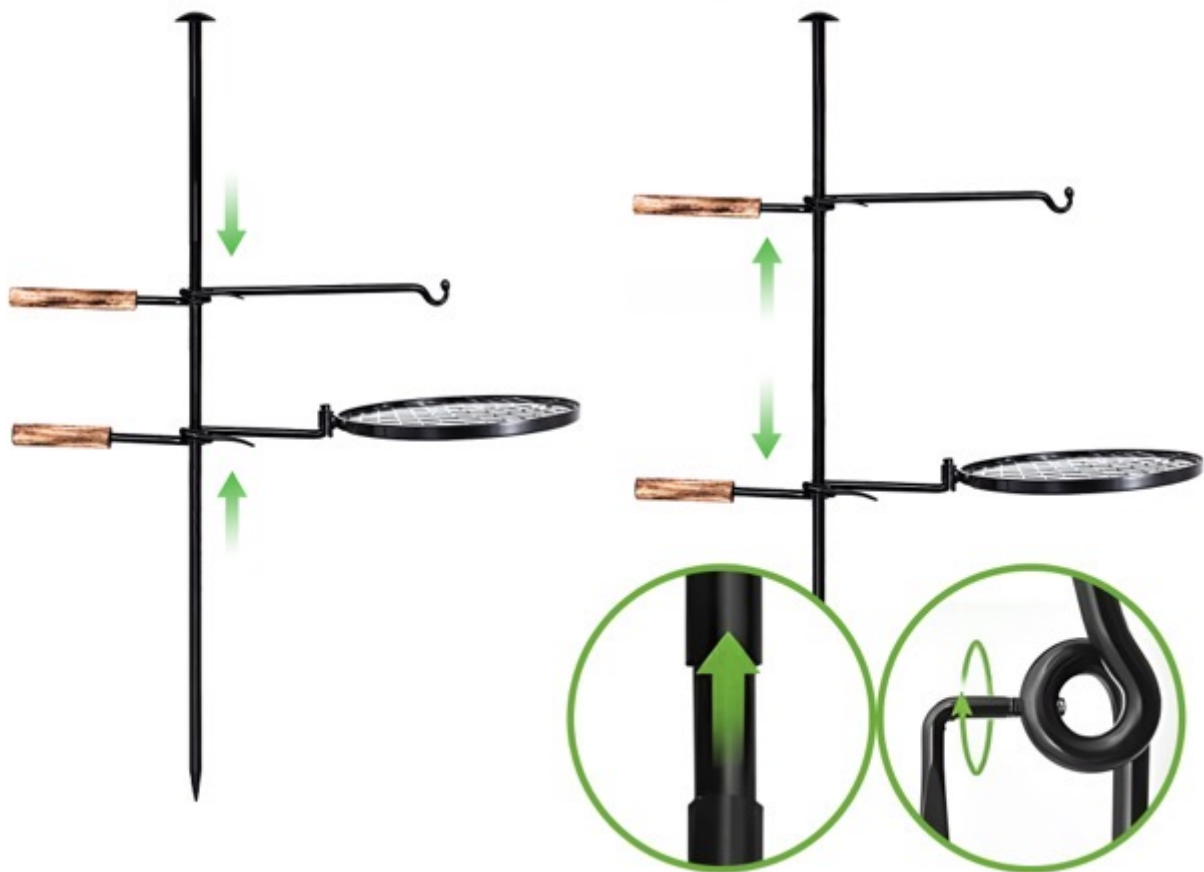

# Easy to Carry

Weighs only **7.5 lbs**



# Optimal Cargo Management

Perfect for securing gear in trucks, SUVs, vans, and on rooftop platforms.



# Two Convenient Sizes

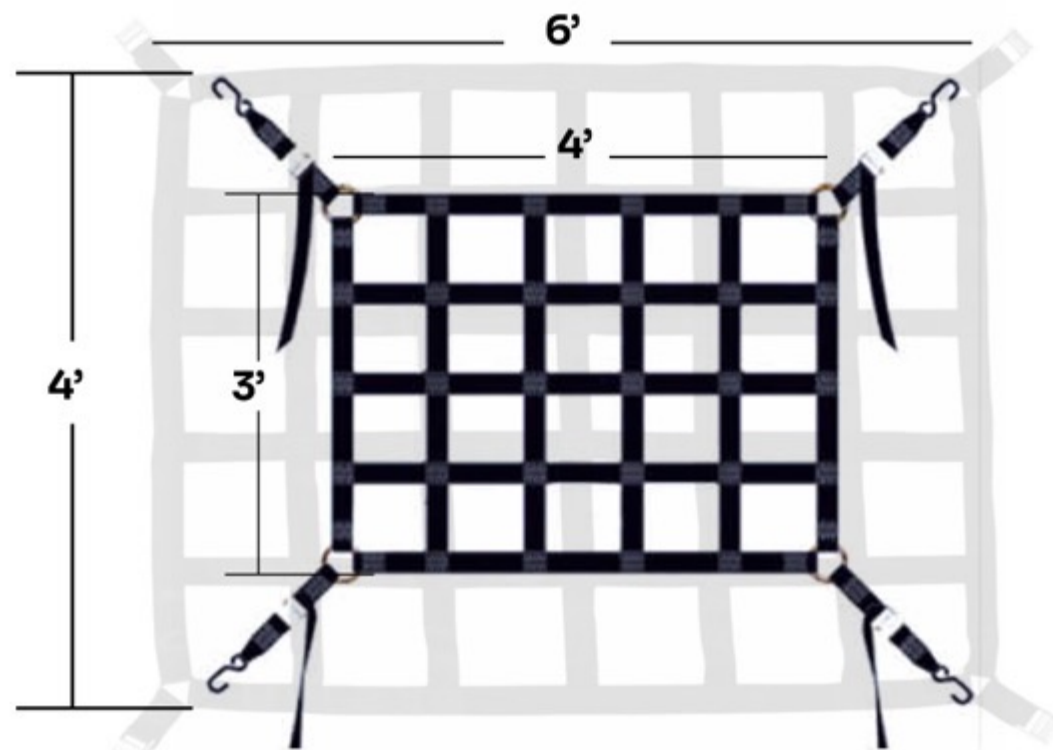

Small: 3 ft x 4 ft (0.91m x 1.22m),  
Large: 4 ft x 6 ft (1.22m x 1.83m)

# Durable Polyester Webbing

- High-quality
- Wear-resistant
- Heavy-duty bungee material



# Ideal for Adventure and Work

Perfect for transporting camping gear,  
tools, and more



# KERMODE TREKCHILL 55L



Total volume of  
**55 liters**

dual-zone feature  
allows you to use it as a

fridge/fridge,

fridge/freezer, or

freezer/freezer.

## Multi Function

Easy to use with APP (For Android/IOS)



-20°C -20°C  
Dual Zone Setting



Fast Cooling  
(MAX/ECO)



Battery Protection  
(H/M/L)



°C / °C



Memory Function



Lock Screen



Real-time  
Temperature  
And Voltage



# Dual Zone Large Capacity



Seafood



Beverages



Vegetables



Fruits



Meats



Skin Care



Length:  
**30 inches**

Width:  
**20 inches**

Height:  
**25 inches**

Weight:  
**50 lbs**

# Compatible with Various Power Sources



Solar Panel / Power Station



110-240V / Home Outlet



12V/24V / Cigarette Lighter



# KERMODE SLIDECHILL 21L



Temperature Range  
**+20°C to -20°C**

## Multi Function

Easy to use with APP (For Android/IOS)

- 20°C -20°C Dual Zone Setting
- Fast Cooling (MAX/ECO)
- Battery Protection (H/M/L)
- 
- °C / °C
- Memory Function
- Lock Screen
- Real-time Temperature And Voltage

# Compatible with Various Power Sources



Solar Panel / Power Station



110-240V / Home Outlet



12V/24V / Cigarette Lighter



Easily set and switch between fridge and freezer modes



Seafood



Beverages



Vegetables



Fruits



Meats



Skin Care



Length:  
27.5 inches

Width:  
17.25 inches

Height:  
9.25 inches

Weight:  
33 lbs

# KERMODE ECOCHILL 55L

Total volume of  
**55 liters**

Offering a temperature  
range from +20°C to -20°C  
(+68°F to -4°F)



## Multi Function

Easy to use with APP (For Android/IOS)



-20°C -20°C  
Dual Zone Setting



Fast Cooling  
(MAX/ECO)



Battery Protection  
(H/M/L)



°C / °C



Memory Function



Lock Screen



Real-time  
Temperature  
And Voltage



# Dual Zone Large Capacity



Seafood



Beverages



Vegetables



Fruits



Meats



Skin Care



Length:  
**26 inches**

Width:  
**17 inches**

Height:  
**22 inches**

Weight:  
**35 lbs**

# Compatible with Various Power Sources



Solar Panel / Power Station

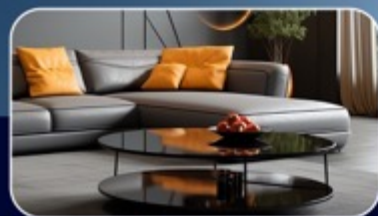

110-240V / Home Outlet



12V/24V / Cigarette Lighter



# KERMODE TREKCHILL 35L



Total capacity of  
**35 liters**  
Left zone of 25 liters Right zone of 10 liters



# Multi Function

Easy to use with APP (For Android/IOS)

-  -20°C -20°C Dual Zone Setting
-  Fast Cooling (MAX/ECO)
-  Battery Protection (H/M/L)
- 



-  °C / °C
-  Memory Function
-  Lock Screen
-  Real-time Temperature And Voltage

# Compatible with Various Power Sources

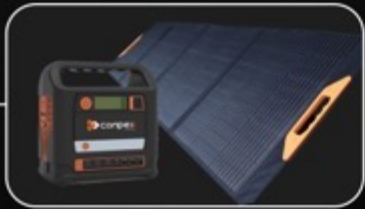

Solar Panel / Power Station



110-240V / Home Outlet



12V/24V / Cigarette Lighter

# Dual Zone Large Capacity



Seafood



Beverages



Vegetables



Fruits



Meats



Skin Care



Length:  
30 inches

Width:  
20 inches

Height:  
12 inches

Weight:  
40 lbs

Tripod  
Stand  
Available



# HIGH POWER

Say goodbye to the darkness and enjoy your night



250 - 300 Sqft

**30W**

LED power output

**5040**

lumens

illuminates an area of approximately **250 to 300** square feet.

# CUSTOMIZABLE LIGHTING

from warm white (3000K)  
to cool white (6500K)



Warm White  
(3000K)



Cool White  
(6500K)



# COMPACT AND PORTABLE DESIGN



USB power cable  
included for  
easy charging



# MEET DIFFERENT NEEDS

With high brightness and wide exposure range,  
it can meet the needs of various environment

NIGHT FISHING



CONSTRUCTION  
NIGHT WORKING



OUTDOOR  
CAMPING



AUTO REPAIR

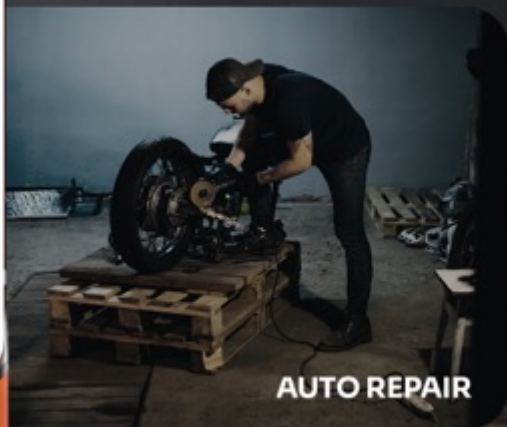

# REMOTE CONTROL

1. Power On/Off

3. Flash Mode

3. Switch



# AUTOSHADE PRO

## AWNING 7-8FT



**TWO SIZES  
AVAILABLE**



CHOOSE FROM **213 X 250 CM** AND **250 X 250 CM** OPTIONS, CATERING TO DIFFERENT VEHICLE TYPES AND SPACE REQUIREMENTS.

- Ensures a perfect fit for various vehicles, from cars to campervans.
- Provides ample shaded areas for outdoor activities like picnics and camping.

# DURABLE VINYL PVC FABRIC



Offers 100% waterproof protection, ensuring dryness during rain showers.

It provides excellent UV resistance, protecting against sun damage and ensuring longevity.

# SEMI-AUTOMATIC CONTROL SYSTEM



**SIMPLIFIES DEPLOYMENT AND RETRACTION WITH MINIMAL EFFORT.**

**ADDS CONVENIENCE TO OUTDOOR ACTIVITIES BY REDUCING SETUP TIME AND EFFORT.**

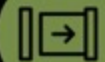

## HEAT INSULATION PROPERTIES

**Offers heat insulation for a cool and comfortable environment underneath.**

**Enhances comfort during hot weather, making it ideal for extended outdoor stays.**

# AUTO SIDE AWNING

## LARGE AND MEDIUM



**UNIVERSAL  
COMPATIBILITY**



Available in two sizes:  
**7ft wide x 6ft long and 8ft wide x 6ft long**

Adjustable poles reach up to 7 ft in height, accommodating various vehicles such as trucks, vans, cars, trailers, and SUVs.

Offers versatile shade and shelter solutions for different vehicle types and outdoor situations.

# ROBUST AND WEATHERPROOF DESIGN



A durable aluminum frame ensures longevity and stability.

Crafted from 420D Oxford fabric known for high waterproof qualities, providing reliable protection in various weather conditions.



# CONVENIENT INSTALLATION AND TRAVEL CASE



- Includes a waterproof travel case with a quality zipper for protection and easy storage.
- Case stays attached to the vehicle, ensuring hassle-free transport.
- Straightforward installation with included mounting hardware, designed for quick setup.

# DURABLE MOUNTING HARDWARE AND WARRANTY



Complete with stainless steel L brackets, nuts and bolts, poles, guide lines, and storage bag/travel case.

Backed by a 1-year limited warranty and CE Certified for safety and durability.

# Gladiator Jeep Bed Rack

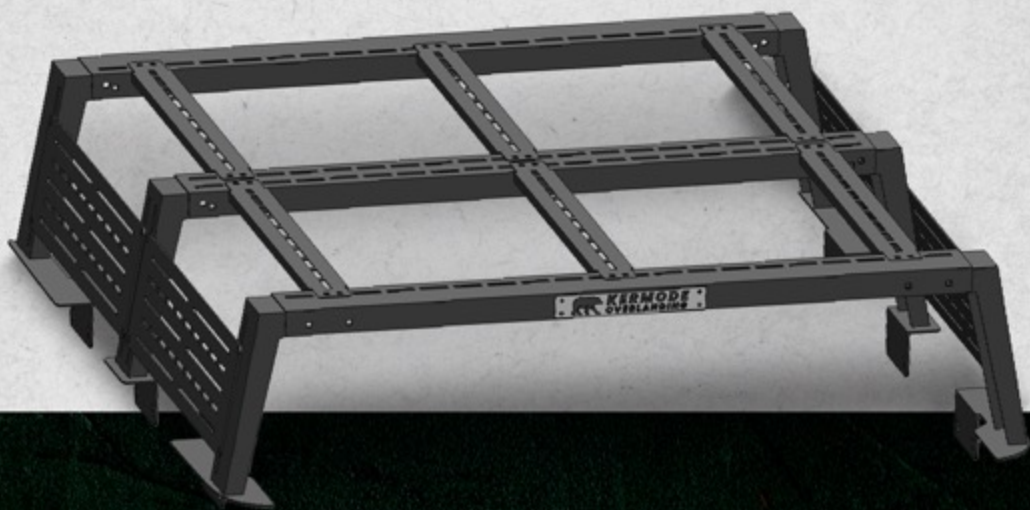

## BUILT FOR STRENGTH:

- **STATIC LOAD CAPACITY:** 450 kg (approximately 992 lbs).
- Ready to bear the weight of your heaviest adventures.

## DURABLE MATERIAL:

- **Construction:** Premium carbon steel with a textured black powder finish.
- **Coating:** Superior E-coating process for unparalleled weather resistance.

# LIGHTWEIGHT DESIGN



**NET WEIGHT:**  
72 kg (approximately 159 lbs).

Adds capability without unnecessary bulk.

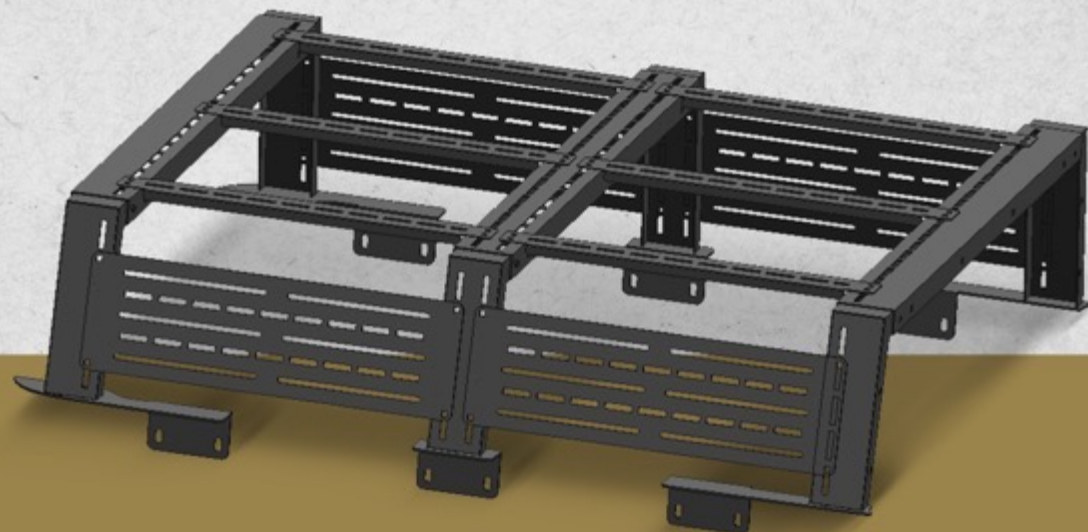

## PERFECT FIT

- Tailor-made for the Jeep Gladiator.
- Seamless integration with your vehicle's aesthetic and design.

## BOLT-ON CONVENIENCE

- Mounts directly to bed rails.
- Fully bolt-on installation with no drilling required.

# YOUR PARTNER IN OVERLANDING ADVENTURES

Ideal for mounting a  
roof top tent for a night  
under the stars.

Perfect for loading up  
recovery gear and other  
essentials.



## SHIPPED DISASSEMBLED



- Arrives ready for assembly.
- Straightforward and simple installation process.



# ENDURA UNIVERSAL

## TRUCK BED RACK SYSTEM



Steel  
Thickness: **3MM**



### SUPERIOR STRENGTH



- ▶ Crafted from extra strong steel.
- ▶ Steel thickness: 3MM (approximately 1/8 inch).
- ▶ Steel tube thickness: 1.5mm (approximately 1/16 inch).



### DURABLE SURFACE TREATMENT

- ▶ Zinc plating and powder coating for maximum protection.
- ▶ Resists corrosion, wear, and tear.

# ADJUSTABLE DIMENSIONS

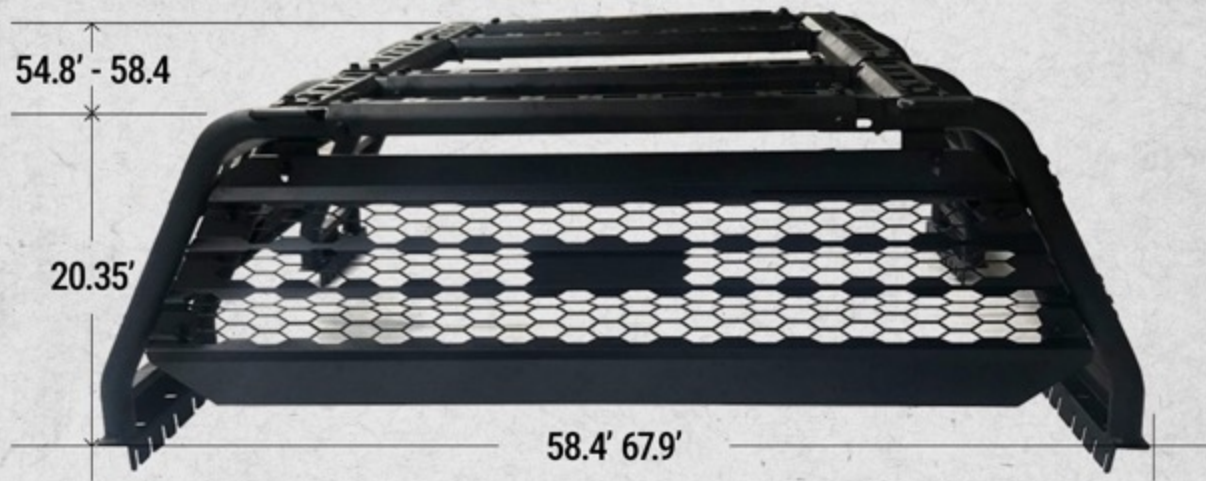

## ADJUSTABLE DIMENSIONS

- ▶ Width: 1484-1726mm (58.4' - 67.9').
- ▶ Height: 517mm (20.35').
- ▶ Length: 1391-1489mm (54.8' - 58.4').



## VERSATILE COMPATIBILITY:

- ▶ Universal pick-up roll bar design.
- ▶ Fits a wide array of truck brands and models.



# INSTALLATION & USE



## EFFORTLESS INSTALLATION

### ROLL BAR FEATURE:

- ▶ Adds to the vehicle's off-road style.
- ▶ Ideal for securing cargo.

### SIMPLE INSTALLATION:

- ▶ No specialist tools are required.
- ▶ Sturdy and straightforward setup.

# Horizon Hauler

## Universal Truck Bed Rack



### ADJUSTABLE HEIGHT & WIDTH



#### HEIGHT RANGE:

16" – 26" to accommodate various truck sizes and needs.

#### FLEXIBILITY:

Width ranging from 51.2" to 66.9".

### DYNAMIC WEIGHT CAPACITY



#### TOTAL WEIGHT:

Approximately 48 lbs (21.77 kg).

### UNIVERSAL TRUCK BED RACK

- **Compatibility:** Fits seamlessly with most major pickup truck brands and models.
- **Design:** No need for professional setup. Includes all necessary tools for straightforward installation.

### DYNAMIC WEIGHT CAPACITY:

- **Dynamic Load:** Supports various gear, including Roof Top Tents and Auto Awnings.
- **Off-Road Capacity:** Handles your heaviest loads with ease.



## DURABLE & RELIABLE

### CONSTRUCTION:

High-quality materials for long-lasting use.

### PERFORMANCE:

Reliable across different environments and uses.



## EFFORTLESS INSTALLATION

### EASY SETUP:

Comes with all necessary fixtures.

### NO DAMAGE:

Ensures installation without damaging your truck bed.

LENGTH:  
**65"**

WIDTH:  
**9.5"**

HEIGHT:  
**7"**

PACKAGE WEIGHT:  
**51 lbs**

## FLEXI LOW PROFILE BED RACK



## UNIVERSAL COMPATIBILITY:

- Designed to fit a multitude of truck models.
- Universally adaptable for diverse cargo management needs.

## FLEXI LOW PROFILE BED RACK



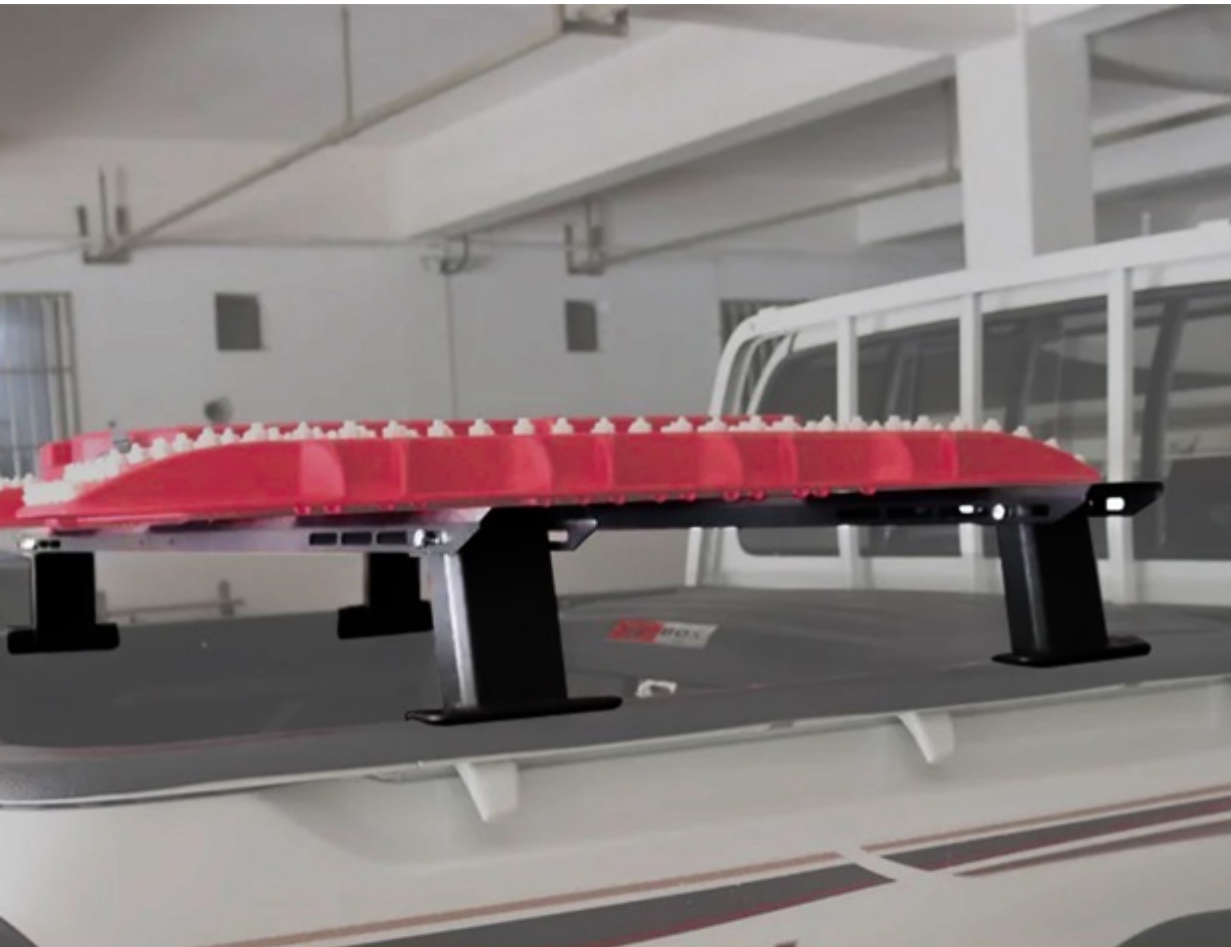

### ROBUST CONSTRUCTION:

- Made from 3MM (approximately 1/8 inch) galvanized steel.
- Built for durability and strength, capable of handling substantial loads.

### STRAIGHTFORWARD INSTALLATION:

- Requires drilling for a secure mount.
- User-friendly design ensures a painless setup process.



### ADAPTABLE FOR VARIOUS NEEDS:

- Suitable for hauling work supplies, adventure gear, or extra cargo space.
- Versatile enough to meet a wide range of hauling requirements.

# Overland Pod Truck Bed Rack System Small & Large

## HIGH-QUALITY MATERIAL:

- Made from premium T6063 Aluminum and MOPE ABS.
- Lightweight yet durable structure for all your gear.

## WIDTH ADJUSTABILITY:

- Adjustable width range from 1600mm to 1800mm (63" to 70.9").
- Custom fit for various truck beds and storage needs.



# MEDIUM POD / BIG POD

## Ideal For

Medium-sized and large-sized trucks needing robust, adaptable storage solutions.



# IMPRESSIVE LOADING CAPACITY

Supports up to  
**250 KGS**  
(approximately 550 LBS).

Ready to bear essential  
**Gear**  
without wavering.



## SECURE GEAR CARRIERS

Easily connect secure gear carriers to the sides.



## SIMPLE INSTALLATION

- Straightforward setup allows for quick preparation.
- Spend more time exploring.



## VERSATILE STORAGE SOLUTIONS

Adapts to carrying camping supplies, recovery equipment, or extra fuel.

With side storage boxes x 2



With side support beam x 2



With expansion boards x2





# TacomaTrail

## Elite Roof Rack (2015-2022)



### VEHICLE COMPATIBILITY:



- Fits Toyota Tacoma models from 2015 to 2022.
- Integrates seamlessly with the vehicle's original mounting holes.

- Enhances cargo capacity for adventurous trips.
- Ideal for carrying extra equipment, gear, and accessories.

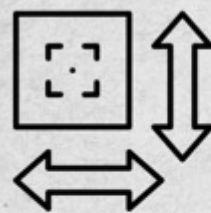

## OVERALL DIMENSIONS

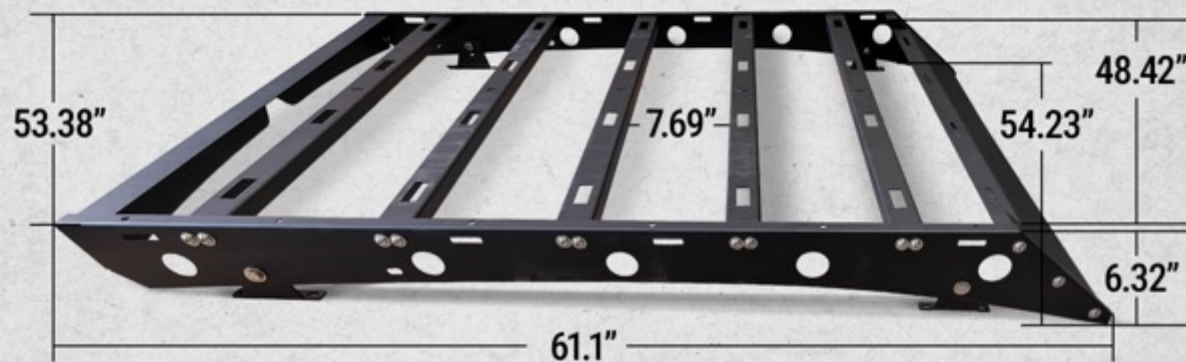

Total Weight:  
Approximately 48 lbs  
(21.77 kg).

- **Width:** 54.23 inches (137.72 cm)
- **Inside Width** (indicates the usable width available for cargo and accessories, excluding the width taken up by the side panels themselves.): 48.42 inches (122.99 cm)
- **Length:** 61.1 inches (155.19 cm)
- **Height Addition:** Adds 7.69 inches (19.53 cm) between crossbars.

# CONSTRUCTION



## CROSSBARS

Made from 3.2" x 0.8"  
(81.28 mm x 20.32 mm)  
aluminum extrusion.



## PANELS

13-gauge (3/32 inch, or  
approximately 2.38 mm)  
high tensile steel.



## FINISH

Textured black powder  
coat and premium  
E-coating for durability  
and weather resistance.



## CROSS BAR ARRANGEMENT:

Includes six extruded aluminum load crossbars, spaced 7.69 inches (19.53 cm) apart.

## EASY INSTALLATION:

- No drilling or vehicle modifications required.
- Comes with all necessary hardware and rubber trim for a straightforward bolt-on installation.



# VERSA UNIVERSAL TRUCK BED RACK SYSTEM

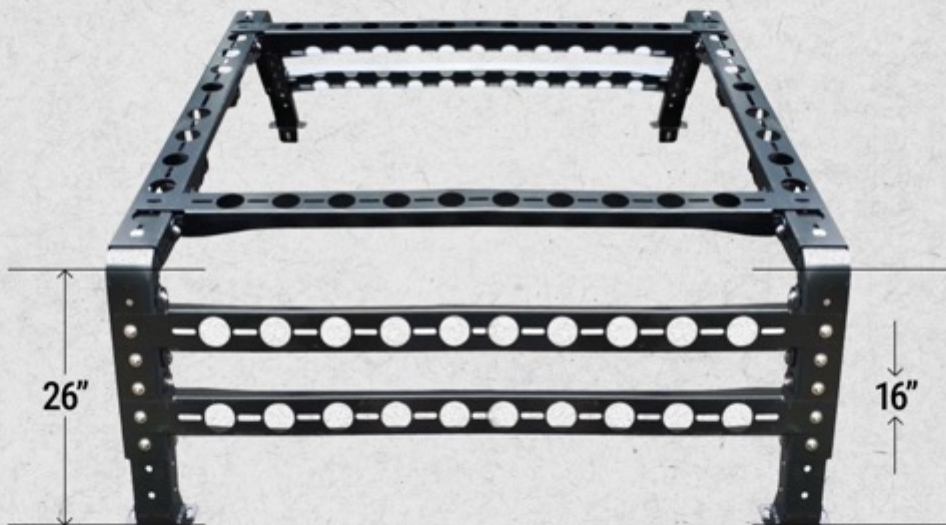

## ADJUSTABLE HEIGHT

**HEIGHT RANGE:**  
Maximum of 26 inches to a minimum of 16.1 inches.

**FLEXIBILITY:**  
Accommodates diverse cargo sizes and needs



## DYNAMIC WEIGHT CAPACITY



**DYNAMIC LOAD:**  
Supports up to 150kg



**OFF-ROAD CAPACITY:**  
Handles up to 115kg

**VERSATILITY:**  
Perfect for various  
demands from leisure  
to work.



## DURABLE & RELIABLE

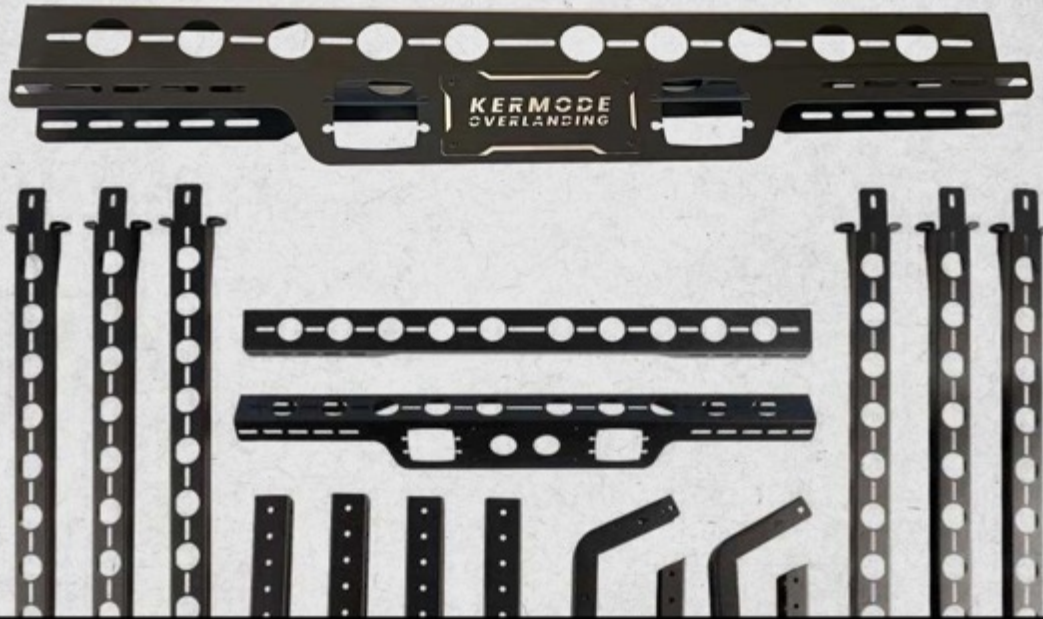

**CONSTRUCTION:**  
High-quality materials for long-lasting use.

**PERFORMANCE:**  
Reliable across different environments and uses.



## EFFORTLESS INSTALLATION

**EASY SETUP:**  
Comes with all necessary fixtures.

**NO DAMAGE:**  
Ensures installation without damaging your truck bed.







**Check The Temperature  
By The Temperature Device**





# P 68 waterproof



## REMOTE CONTROL

One-Button Remote Control,  
More Convenient





# UNIQUE CYLINDER PACKING DESIGN

Waterproof and fall-resistant, easy carry and storage  
Convenient for your life



Shoulders



Portable





Light Page Can  
**ROTATED 360°**

# WITHOUT REWIRING

Wires are directly connected to the bottom

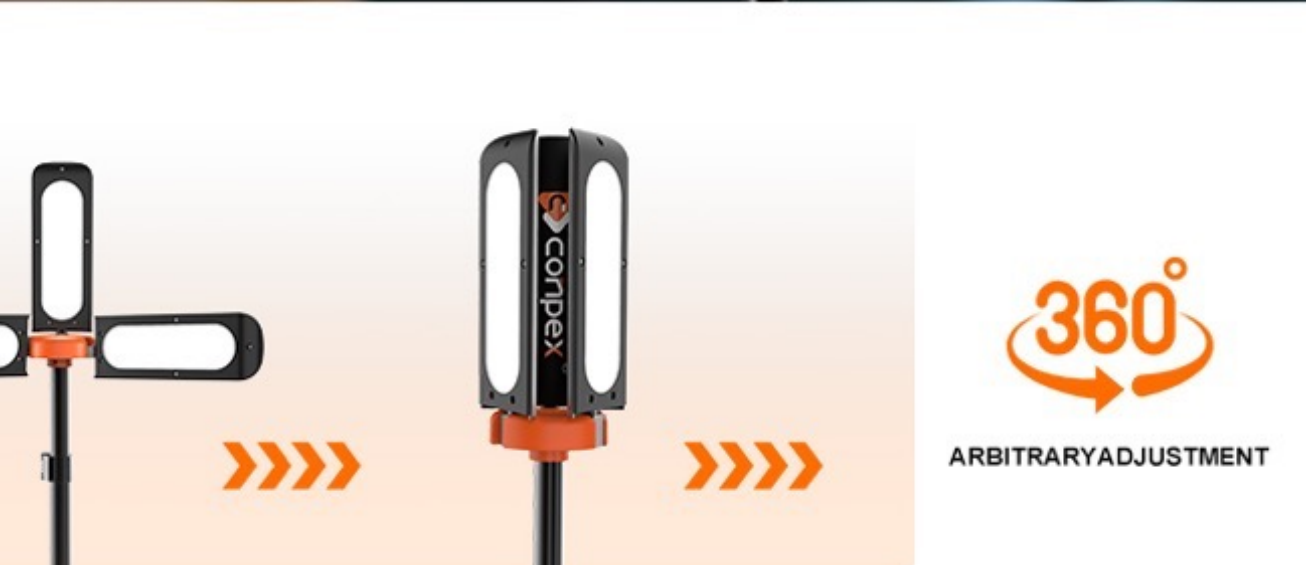

**360°**  
ARBITRARY ADJUSTMENT